

SST Pedestal Kiosk with Booster Standing Frame

Quick Start Guide

Part# 15301-GA0xx

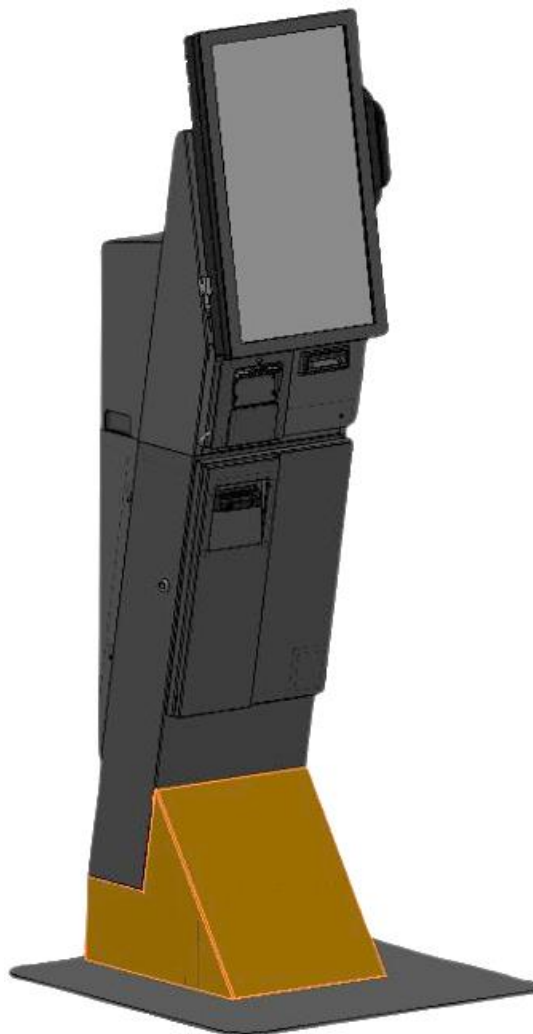

SST Pedestal Kiosk with Booster Standing Frame

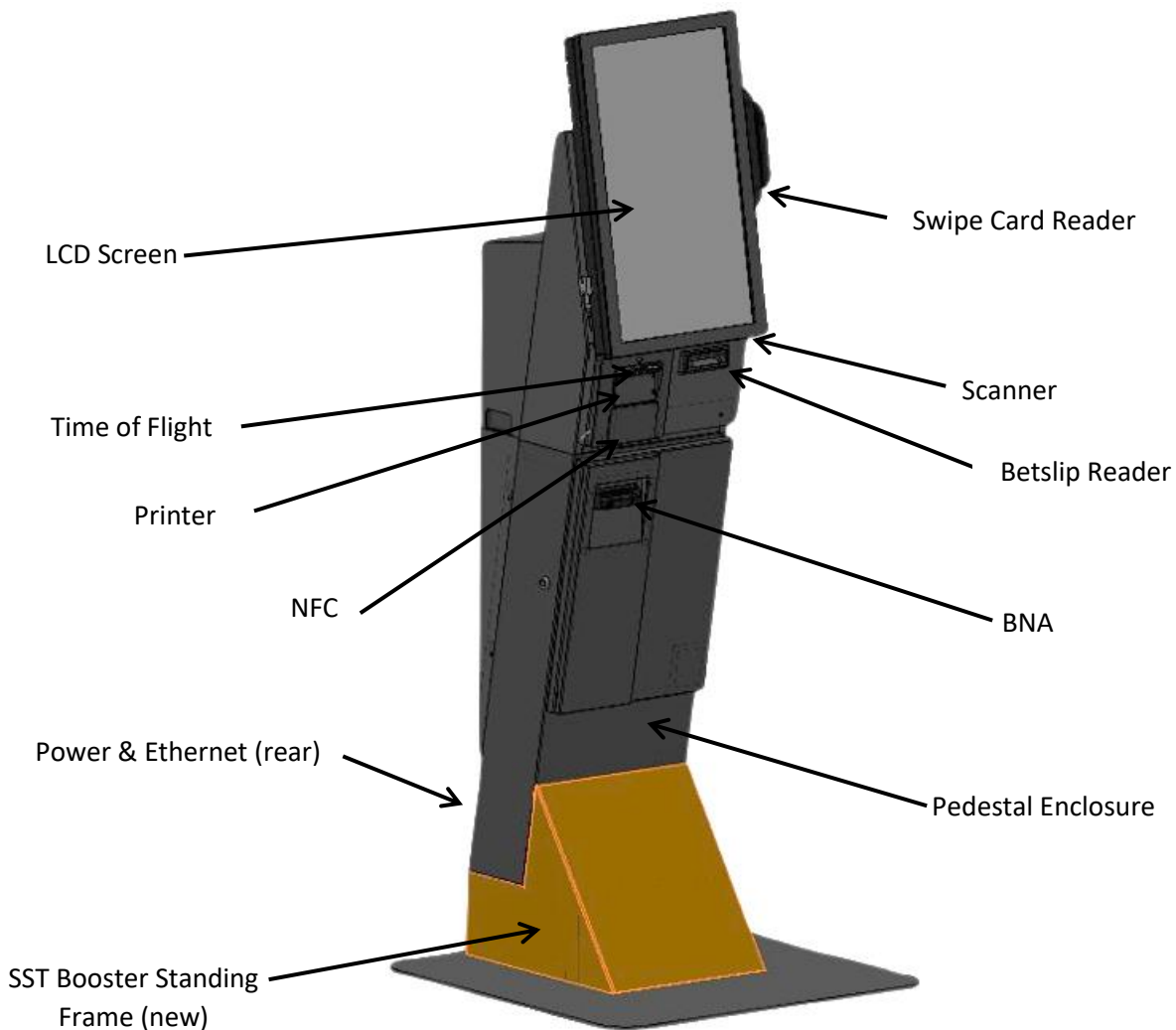

Component descriptions



1.0 Keys required

	<p>SST Kiosk LCD Screen Door: <u>T0001.</u></p> <p>Identification: <u>southco</u></p>
	<p>Desk BNA Enclosure, Wall Mount Enclosure & Pedestal Enclosure: <u>002.</u></p>
	<p>MEI Cashbox: <u>5031.</u></p>

2.0 Unpacking Kiosk

	<p>Cut the packaging Tape from the carton.</p>
	<p>Remove the documentation from the foam packaging and retain for future reference.</p>
	<p>Carefully remove the SST Booster Standing Frame & Booster Standing Frame Back from the carton. Discard the packaging.</p>

3.0 Disassembling the SST Pedestal from Pedestal Base

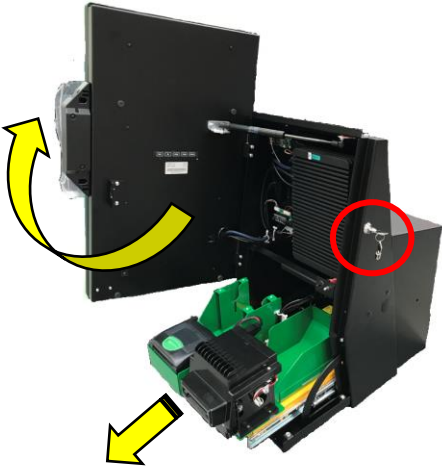
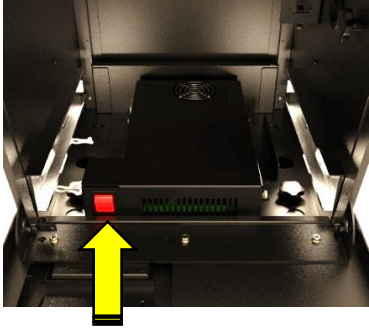
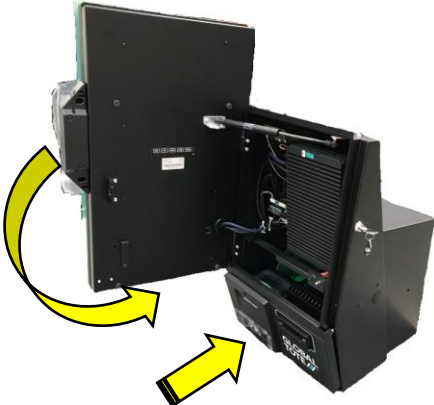
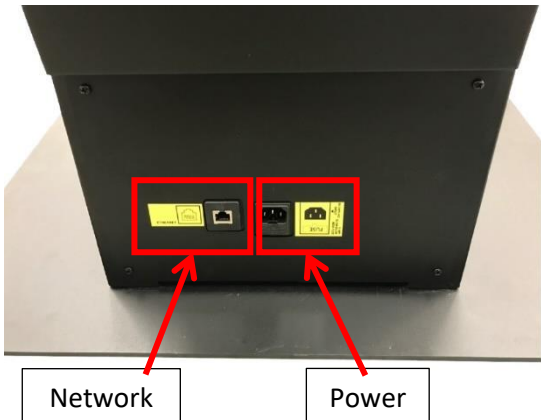
	<p>Open the LCD Screen Door and Lower Door by unlocking the Lock at the right-hand side of the Kiosk using Key#: <u>T0001</u> provided.</p> <p>Slide out the Peripheral Drawer.</p>
	<p>Switch unit from O → I.</p> <p>Note: Components removed for clarity.</p>
	<p>Slide Peripheral Drawer assembly back into position.</p> <p>Close Lower Door, LCD Screen Door & lock.</p>
	<p>At the rear of the Pedestal, remove the Network cable & earthed IEC cable from locations as shown.</p>

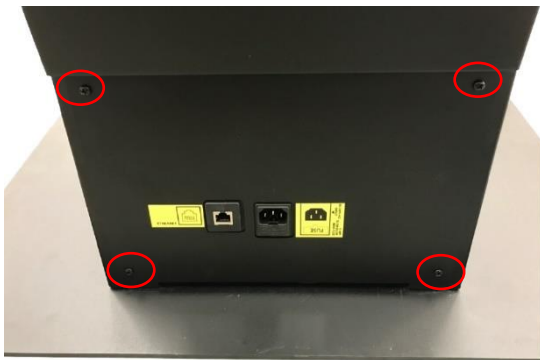
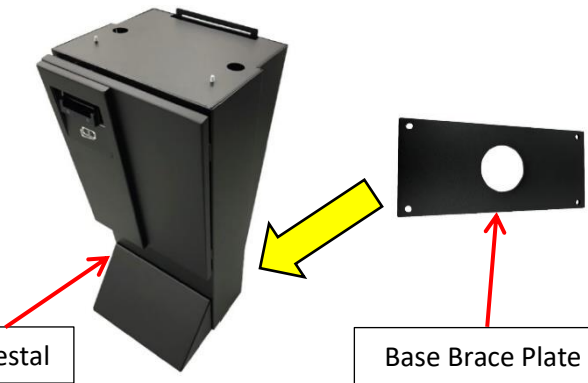
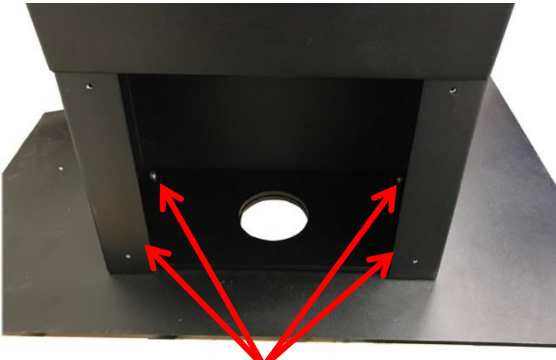
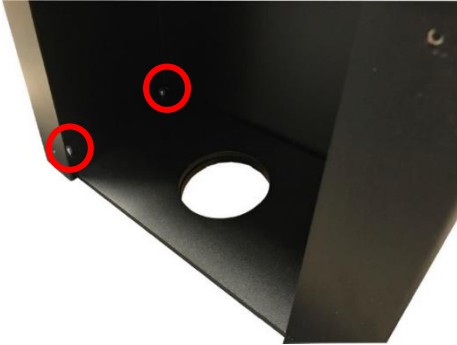

3.0 Disassembling the SST Pedestal from Pedestal Base (continued)

	<p>To access the fastening of the Pedestal to the Base Plate, the Standing Pedestal Rear Plate needs to be removed.</p> <p>Remove & retain the 4x M4 Pan Head Screws from the Standing Pedestal Rear Plate using a #2 Phillips Head Screwdriver.</p> <p>The Standing Pedestal Rear Plate will be connected to the internal Looms. Store the Standing Pedestal Rear Plate on the side of the Pedestal for fitment at a later Step.</p>
 <p>Pedestal</p> <p>Base Brace Plate</p>	<p>To allow separation of the Pedestal to the Base Plate, the Base Brace Plate will be removed from the inside of the Pedestal at the rear.</p>
	<p>Remove & retain 4x M8 Nylock Nuts using a 13mm Open End Ring Spanner.</p>
	<p>The Base Brace Plate is positioned over the 4x thread studs (2x LHS shown).</p>

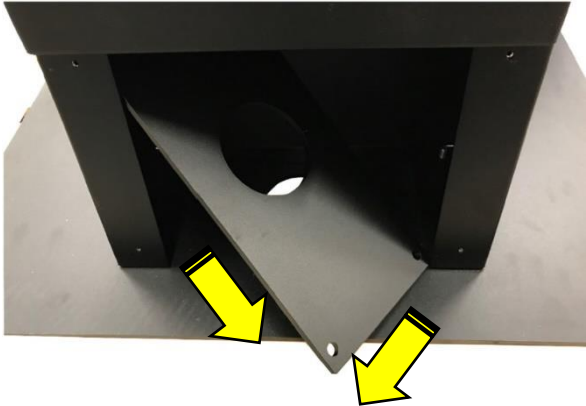
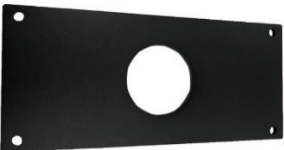
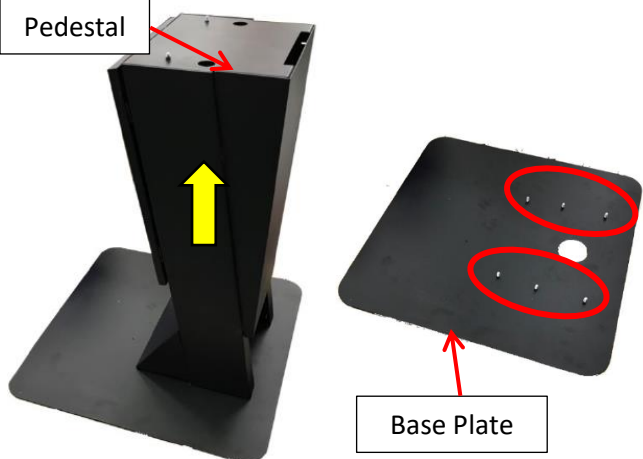
3.0 Disassembling the SST Pedestal from Pedestal Base (continued)

	<p>Orientate the Base Brace Plate through the rear opening of the Pedestal.</p> <p>Lift the left-hand side of the Base Brace Plate upwards & pull the bottom right hand side corner to the front of Pedestal in the orientation shown.</p>
	<p>Retain the Base Brace Plate for fitment in later Step.</p>
	<p>Pedestal + Kiosk requires a two-person lift.</p> <p>Lift & remove the Pedestal from the 6x threaded studs on the Base Plate.</p> <p>Note: Kiosk removed for clarity.</p> <p>Store the Pedestal + Kiosk in a safe location for fitment in later Step.</p>

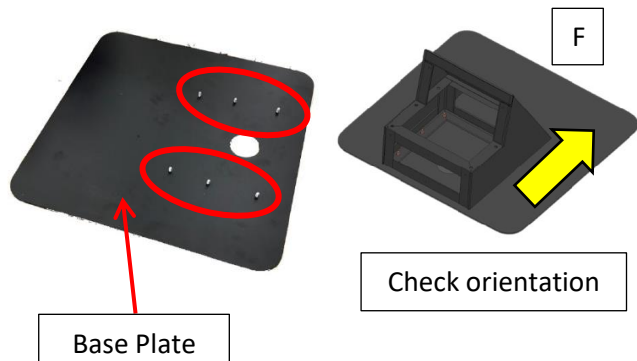
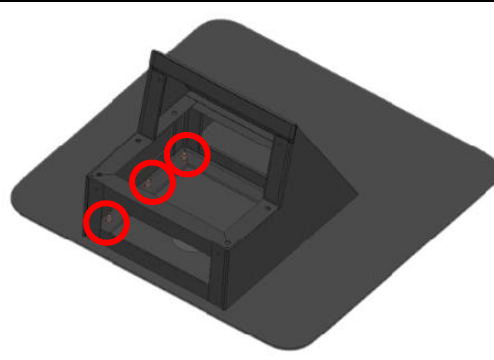
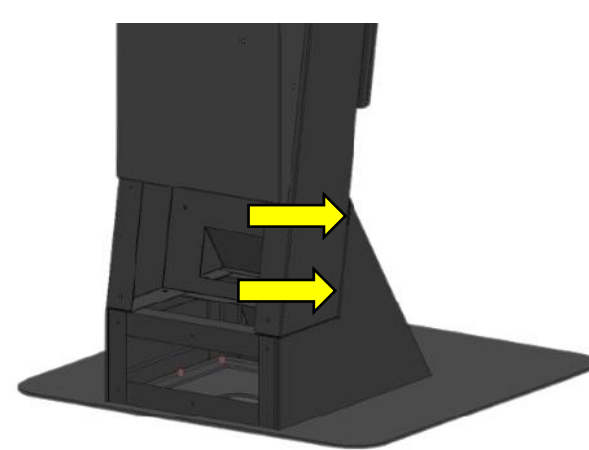
3.0 Installing SST Booster Standing Frame components to SST Base

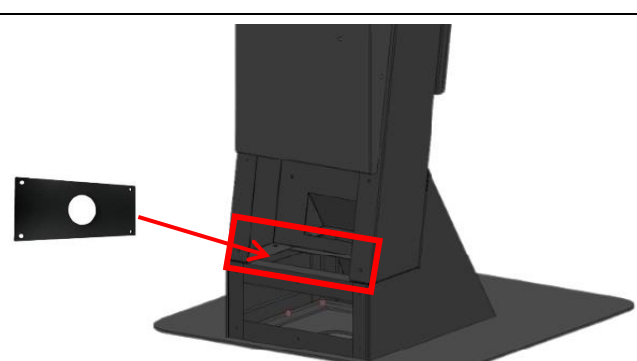
 <p>Base Plate</p> <p>Check orientation</p>	<p>The SST Booster Standing Frame will be positioned in same fastening locations as the previously removed Pedestal.</p> <p>Install the SST Booster Standing Frame over the 6x threaded studs on the Base Plate.</p>
	<p>Install 6x M8 Nylock Nuts & fasten using a 13mm Open End Ring Spanner (3x LH Side & 3x RH Side) → 3x LHS shown.</p>
	<p>Pedestal + Kiosk requires a two-person lift.</p> <p>Lift & install the Pedestal + Kiosk onto the SST Booster Standing Frame.</p> <p>Position the “vertical” face of the Pedestal against the SST Booster Standing Frame in areas highlighted.</p> <p>Caution: The Pedestal + Kiosk is heavy - support of the Kiosk is required until the Pedestal is clamped onto the SST Booster Standing Frame.</p> 
	<p>The Base Brace Plate is to be re-installed into the bottom of the Pedestal in the position highlighted.</p>

3.0 Installing SST Booster Standing Frame components to SST Base (cont'd)

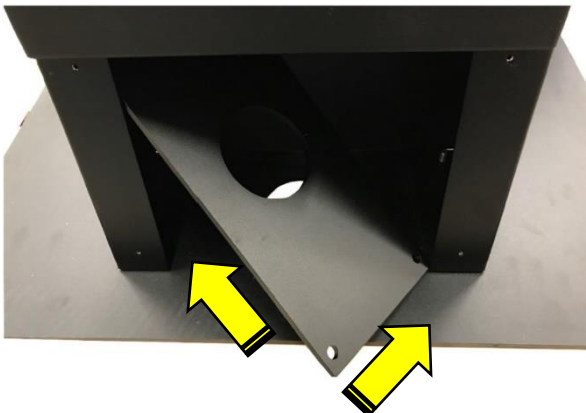
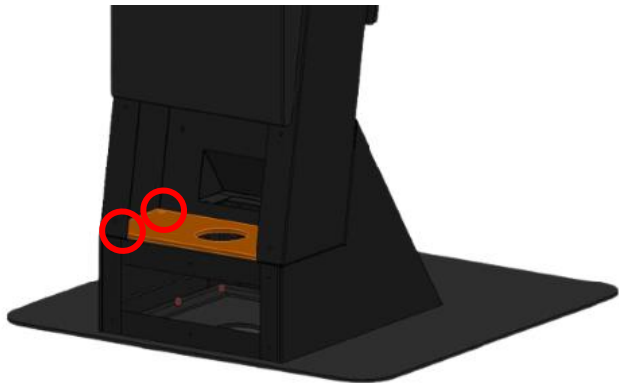
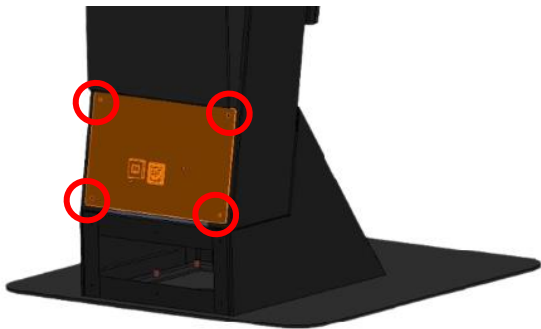
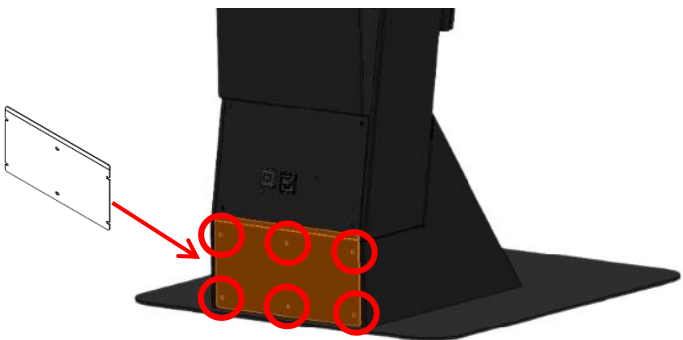
	<p>Note: Image is for reference only.</p> <p>Orientate the Base Brace Plate through the rear opening of the Pedestal.</p> <p>Lift the left-hand side of the Base Brace Plate upwards & push the bottom right hand side corner to the rear of Pedestal in the orientation shown.</p>
	<p>Once positioned, the Base Brace Plate will locate as shown.</p> <p>Instal 4x M8 Screws from the top through the holes to connect the Pedestal & SST Booster Standing Frame (2x LH Side & 2x RH Side) → 2x LHS shown.</p> <p>Install the 4x Nylock Nuts onto the 4x M8 Screws from underside.</p> <p>Fasten using a #2 Phillips Head Screwdriver & 13mm Open End Ring Spanner.</p>
	<p>Check that the Looms are fully connected to the Network & IEC ports in the Standing Pedestal Rear Plate.</p> <p>Re-install the Standing Pedestal Rear Plate with 4x M4 Pan Head Screws & fasten using a #2 Phillips Head Screwdriver.</p>
	<p>Install the Booster Standing Frame Back with 6x M4 Pan Head Screws & fasten using a #2 Phillips Head Screwdriver.</p>

3.0 Installing SST Booster Standing Frame components to SST Base (cont'd)

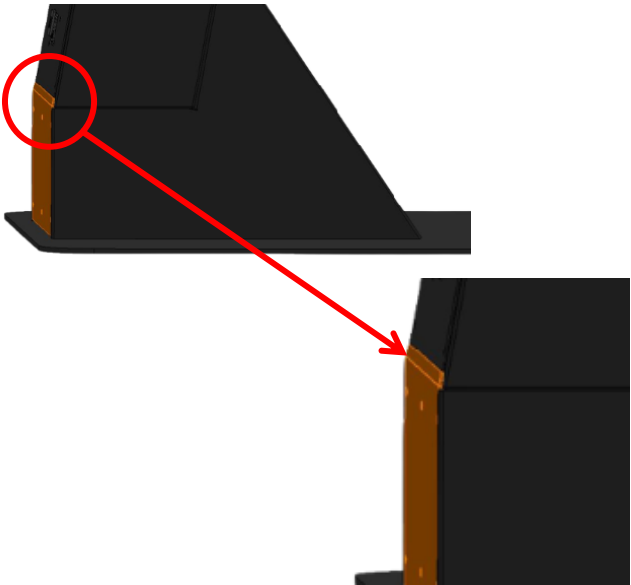
	<p>Check that the top angle feature of the Booster Standing Frame Back is orientated towards the Pedestal as shown. This closes the join between the Pedestal & Booster Standing Frame Back.</p>
---	--

4.0 Power up the Kiosk

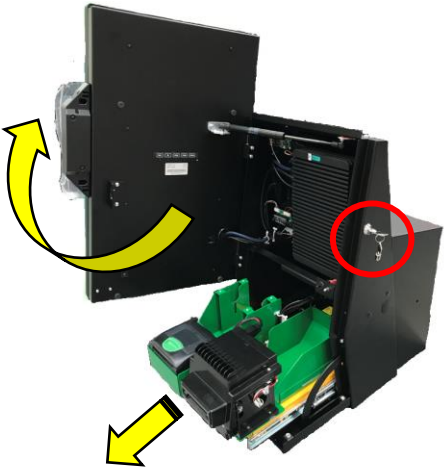
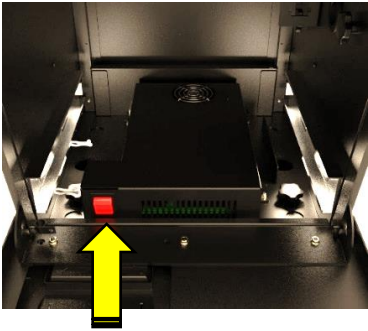
	<p>Open the LCD Screen Door and Lower Door by unlocking the Lock at the right-hand side of the Kiosk using Key#: T0001 provided.</p> <p>Slide out the Peripheral Drawer.</p>
	<p>Switch unit from O → I.</p> <p>Note: Components removed for clarity.</p>

4.0 Power up the Kiosk (continued)

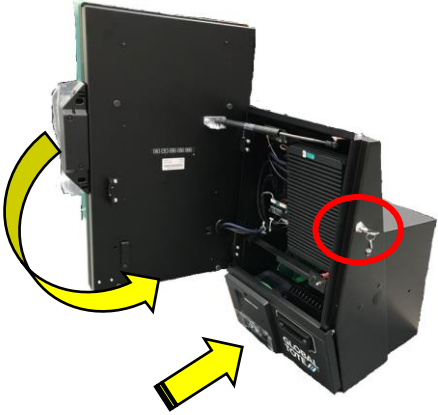
	<p>Slide Peripheral Drawer back into position.</p> <p>Close Lower Door, LCD Screen Door & lock.</p>
---	---